

Fiche de réglage MP9 WC

ver.1.00 WC

Nom du pilote		Date	Course	Moteur	Bougie	Carburant
Cour. Central.	Cloche/Embrayage/Ressort		Insert/Type/Marque			Résonateur
T	T	<input type="checkbox"/> 1.10 <input type="checkbox"/> 1.00 <input type="checkbox"/> 0.95 <input type="checkbox"/> 0.90	Carbon X _____	Type :	Marque :	
			Aluminum X _____	Insert :		

Type d'amortisseur	Avant	Arrière
Piston d'amortisseur	<input type="checkbox"/> ϕ 1.2x6 B <input type="checkbox"/> ϕ 1.2x8 B <input type="checkbox"/> ϕ 1.2x8 T <input type="checkbox"/> ϕ 1.3x5 B <input type="checkbox"/> ϕ 1.3x6 W <input type="checkbox"/> ϕ 1.3x8 W <input type="checkbox"/> ϕ 1.3x8 T <input type="checkbox"/> ϕ 1.4x5 W <input type="checkbox"/> ϕ 1.4x8 T	<input type="checkbox"/> ϕ 1.2x6 B <input type="checkbox"/> ϕ 1.2x8 B <input type="checkbox"/> ϕ 1.2x8 T <input type="checkbox"/> ϕ 1.3x5 B <input type="checkbox"/> ϕ 1.3x6 W <input type="checkbox"/> ϕ 1.3x8 W <input type="checkbox"/> ϕ 1.3x8 T <input type="checkbox"/> ϕ 1.4x5 W <input type="checkbox"/> ϕ 1.4x8 T
Huile	#	#
Ressort		

B = Black
W = White
T = Taper

● Garde au sol

Avant	Arrière
mm	mm

● Rebond

Avant	Arrière
mm	mm

● Carrossage

Avant	Arrière
+ ° -	+ ° -

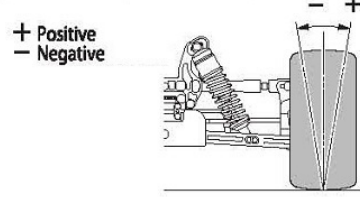
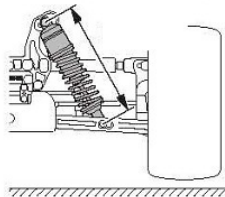

● Angle de l'anti-plongé avant

Sup.	Face avt	<input type="checkbox"/> <input type="checkbox"/> <input type="checkbox"/> <input type="checkbox"/> <input type="checkbox"/> <input type="checkbox"/> <input type="checkbox"/> <input type="checkbox"/> <input type="checkbox"/> <input type="checkbox"/>
	Fac arr	<input type="checkbox"/> <input type="checkbox"/> <input type="checkbox"/> <input type="checkbox"/>
Inf.	Face avt	<input type="checkbox"/> 9°L <input type="checkbox"/> <input type="checkbox"/> <input type="checkbox"/> 11°L <input type="checkbox"/> <input type="checkbox"/> <input type="checkbox"/> <input type="checkbox"/> 9°S <input type="checkbox"/> <input type="checkbox"/> 11°S <input type="checkbox"/> <input type="checkbox"/>

● Porte fusée avt Sup.

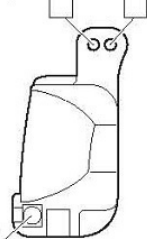

● Voie avant

<input type="checkbox"/> S	<input type="checkbox"/> <input type="checkbox"/> <input type="checkbox"/> <input type="checkbox"/>
<input type="checkbox"/> L	<input type="checkbox"/> <input type="checkbox"/> <input type="checkbox"/> <input type="checkbox"/>

● Insert porte fusée avant

<input type="checkbox"/> -1°	<input type="checkbox"/> 0°	<input type="checkbox"/> +1°
<input type="checkbox"/> Plastic	<input type="checkbox"/> Aluminum	

● Position des amortisseurs : sur le support

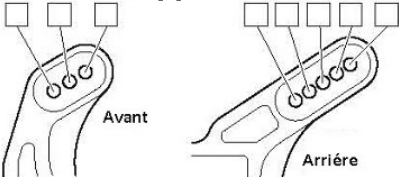

sur les triangles inf.

Avant	Arrière
<input type="checkbox"/> In <input type="checkbox"/> Out	<input type="checkbox"/> In <input type="checkbox"/> Out

Sup. amortisseur ar.

<input type="checkbox"/> IFW408 TKI2	<input type="checkbox"/> IF437 TKI
--------------------------------------	------------------------------------

● Différentiel

	Avant	Centre	Arrière
Huile	<input type="checkbox"/> Normal <input type="checkbox"/> LSD	<input type="checkbox"/> Normal <input type="checkbox"/> LSD	<input type="checkbox"/> Normal <input type="checkbox"/> LSD

● Pincement

Avant	Arrière
+ ° -	<input type="checkbox"/> 2° <input type="checkbox"/> 2.5° <input type="checkbox"/> 3°

● Empattement

Empattement
Epaisseur de la rondelle placée
avt la fusée arr _____ mm
ap la fusée arr _____ mm

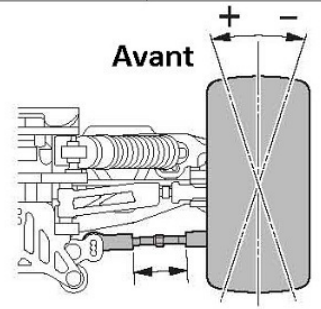

● Réglage du Centre de roulis et de l'anticabrage

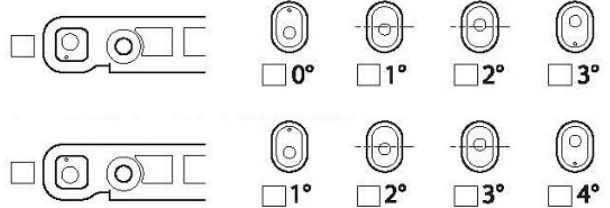

● Position triangle supérieur

	Arrière
Côté amor	<input type="checkbox"/> 1 <input type="checkbox"/> 2 <input type="checkbox"/> 3 <input type="checkbox"/> 4 <input type="checkbox"/> 5 <input type="checkbox"/> 6 <input type="checkbox"/> 7 <input type="checkbox"/> 8 <input type="checkbox"/> 9 <input type="checkbox"/> 10
Côté roue	<input type="checkbox"/> 1 <input type="checkbox"/> 2 <input type="checkbox"/> 3 <input type="checkbox"/> 4

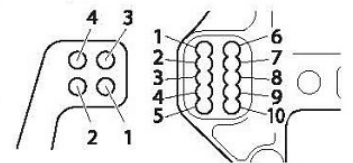

● Fusée arrière

<input type="checkbox"/> IFW410 TKI2 (Alu)
<input type="checkbox"/> TKI (Plastic)

● Barre ackerman

<input type="checkbox"/> A	<input type="checkbox"/> F ↑
<input type="checkbox"/> B	
<input type="checkbox"/> C	<input type="checkbox"/> F ↓

● Position de la fusée arrière

<input type="checkbox"/> Dessus	<input type="checkbox"/> Dessous
---------------------------------	----------------------------------

● Barre de renfort châssis

Avant	Arrière
<input type="checkbox"/> Plastic	<input type="checkbox"/> Plastic
<input type="checkbox"/> Aluminum	<input type="checkbox"/> Aluminum

● Position de la barre anti-roulis

Avant	Arrière
ϕ	ϕ
mm	mm

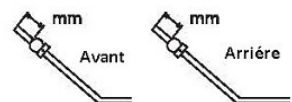

● Position de l'aileron

<input type="checkbox"/> Dessus	<input type="checkbox"/> Dessous
---------------------------------	----------------------------------

● Position de l'accus

<input type="checkbox"/> Avant	<input type="checkbox"/> Arrière
--------------------------------	----------------------------------

● Adaptateur de roue

Avant	Arrière
<input type="checkbox"/> IFW326 étroit <input type="checkbox"/> IFW107 normal	<input type="checkbox"/> IFW326 étroit <input type="checkbox"/> IFW107 normal

● Poids

--